

# Percutaneous Dilatational Tracheostomy

## PRODUCT CATALOG

**Primed<sup>®</sup>**



**Primed<sup>®</sup> Medizintechnik GmbH** is a highly experienced manufacturer of medical devices in the field of tracheostomy and laryngectomy.

For many years we have been supplying our customers with high quality products "MADE IN GERMANY".

According to our corporate philosophy, the **Primed<sup>®</sup>** range of medical products is developed, manufactured and distributed exclusively in our company. This is done in close cooperation with our customers as well as scientific institutions.

On the basis of a certified development process according to DIN EN 13485, highly innovative medical products are developed as a result of continuous market monitoring and analysis.

Our production covers the entire manufacturing process (injection moulding/ extrusion/ assembly), up to sterilization in our own EO sterilization facility.

The merging of all product relevant processes in one company enables us to react in an extremely flexible way to market requirements. Thus we can ensure the continuous development of our products and can also place new products on the market.

PDT SETS (Percutaneous dilatational tracheostomy sets)  
with Optima PercuTrach® .....4

**PERCUTRACH®** PDT Set Type 1 ..... 5

**PERCUTRACH®** PDT Set Type 2 ..... 13

Set Components .....20

Dilation Sets..... 21

**PERCUTRACH®** Dilation Set I ..... 22

**PERCUTRACH®** Dilation Set II ..... 23

**OPTIMA PERCUTRACH®** with atraumatic inserter..... 24

Accessories..... 27

## PDT SETS

(PERCUTANEOUS DILATATIONAL TRACHEOSTOMY SETS)

WITH OPTIMA PERCUTRACH®

Percutaneous dilatational tracheostomy is a standardized method in intensive medical treatment. As alternative for surgical tracheostomy it may be carried out less time-consuming at the bedside in ICU's.

The dilated tracheostoma closes spontaneously and long-term cosmetic results are far superior to conventional tracheostomy.

All **Primed®** PDT sets include a dilation set and a matching tracheostomy tube set (Optima PercuTrach®).

PDT set type 1 includes a dilation set for the Ciaglia dilation technique and an Optima PercuTrach® tracheostomy tube with atraumatic inserter.

PDT set type 2 includes a dilation set for the Griggs dilation technique, with tracheal dilating forceps, and an Optima PercuTrach® tracheostomy tube with atraumatic inserter.

Our dilation sets are ideally adapted to the use of Optima PercuTrach® tracheostomy tubes which are available with or without phonation window and with or without subglottic suction line.

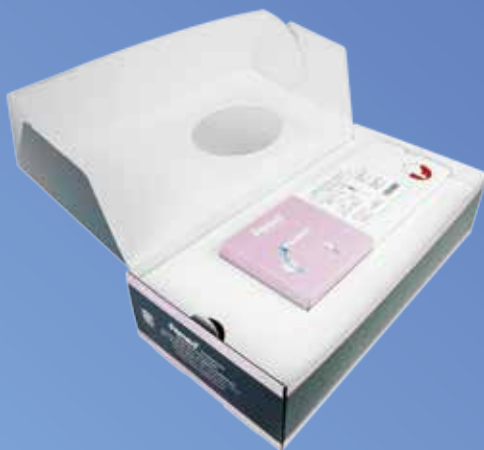

PDT SET TYPE 1



# DILATATION TRACHEOSTOMY

DEVELOPED BY CIAGLIA

The percutaneous dilatation tracheostomy technique according to Ciaglia is a minimal-invasive treatment which implies the stepless bouginage of the trachea by a conically shaped dilator via guide wire, thus enabling the insertion of a suitable tracheostomy tube.

**Primed®** PDT Set Type 1 includes a conically shaped dilator which has a hydrophilic coating for assuring good gliding capabilities. After removing the dilator, the tracheostomy tube can be gently placed in the trachea via the atraumatic inserter.

The procedure is performed under bronchoscopic control.



Position patient with hyperextension of neck, cover area around the neck with sterile dressing, disinfect skin

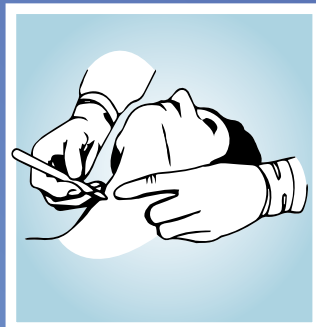

Palpation of neck, sonography (recommended), diaphanoscopy of neck area (obligatory), horizontal incision(1,5-2,0 cm) and blunt preparation up to trachea



Puncture of trachea



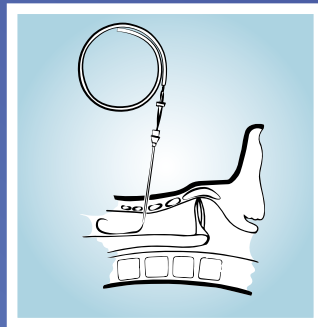

Insertion of guide wire (Seldinger wire)



Pre-dilation of injection canal by pre-dilator, removing of pre-dilator

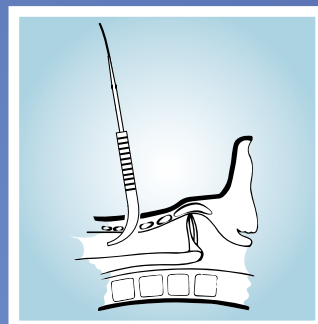

Moisten dilator.  
Push dilator with inserted guiding catheter into the trachea via guide wire up to the required size of tracheal orifice. After that, remove dilator and guiding catheter simultaneously.

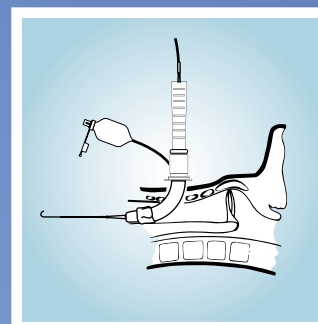

Moisten tip of atraumatic inserter with lubricant and insert in tracheal orifice via guide wire together with tested tracheostomy tube. Remove atraumatic inserter and guide wire simultaneously.

**PERCUTRACH® PDT SET TYPE 1**

**Package contents per set:**

**PERCUTRACH®** Dilation set I

Including:

- pre-dilator (14 CH)
- puncture cannula (14G)
- dilator (hydrophilic coating)
- guiding catheter with safety lock
- guide wire with dispenser
- gauze compresses
- syringe
- scalpel

*and*

**OPTIMA PERCUTRACH®** Basic Cuff

with atraumatic inserter

Including:

- outer cannula with cuff and 15 mm universal connector
- atraumatic inserter
- 1 transparent, unfenestrated inner cannula
- 1 white, unfenestrated, radiopaque inner cannula
- obturator, perforated
- neck strap
- lubricant gel

PU = 1 set  
sterile packaged



SIZE	ID <sub>IC</sub>	ID <sub>OC</sub>	OD	LENGTH ALONG CENTRE LINE (OC)	LENGTH ALONG OUTER BEND (OC)	ARTICLE NUMBER PDT SET
7	5,4 mm	7,0 mm	10,5 mm	70,0 mm	79,0 mm	112424
8	6,4 mm	8,0 mm	11,6 mm	75,5 mm	87,0 mm	112425
9	7,4 mm	9,0 mm	12,6 mm	81,0 mm	93,0 mm	112426

ID = INNER DIAMETER  
OD = OUTER DIAMETER  
PU = PACKAGING UNIT

IC = INNER CANNULA  
OC = OUTER CANNULA

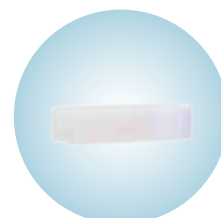

**OBTURATOR & NECK STRAP INCLUDED**



PERCUTRACH® PDT SET TYPE 1



Package contents per set:

**PERCUTRACH®** Dilation set I

Including:

- pre-dilator (14 CH)
- puncture cannula (14G)
- dilator (hydrophilic coating)
- guiding catheter with safety lock
- guide wire with dispenser
- gauze compresses
- syringe
- scalpel

and

**OPTIMA PERCUTRACH®** Voice Cuff

with atraumatic inserter

Including:

- fenestrated outer cannula with cuff and 15 mm universal connector
- atraumatic inserter
- 1 red, fenestrated inner cannula
- 1 white, unfenestrated, radiopaque inner cannula
- obturator, perforated
- decannulation cap
- speaking valve
- neck strap
- lubricant gel

PU = 1 set  
sterile packaged



SIZE	ID <sub>ic</sub>	ID <sub>oc</sub>	OD	LENGTH ALONG CENTRE LINE (OC)	LENGTH ALONG OUTER BEND (OC)	ARTICLE NUMBER PDT SET
7	5,4 mm	7,0 mm	10,5 mm	70,0 mm	79,0 mm	112434
8	6,4 mm	8,0 mm	11,6 mm	75,5 mm	87,0 mm	112435
9	7,4 mm	9,0 mm	12,6 mm	81,0 mm	93,0 mm	112436

ID = INNER DIAMETER  
OD = OUTER DIAMETER  
PU = PACKAGING UNIT

IC = INNER CANNULA  
OC = OUTER CANNULA

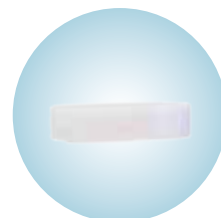

OBTURATOR & NECK STRAP INCLUDED

**PERCUTRACH® PDT SET TYPE 1**

**Package contents per set:**

**PERCUTRACH®** Dilatation set I

Including:

- pre-dilator (14 CH)
- puncture cannula (14G)
- dilator (hydrophilic coating)
- guiding catheter with safety lock
- guide wire with dispenser
- gauze compresses
- syringe
- scalpel

*and*

**OPTIMA PERCUTRACH®** Suction with atraumatic inserter

Including:

- outer cannula with cuff, subglottic suction function and 15 mm universal connector
- atraumatic inserter
- 1 transparent, unfenestrated inner cannula
- 1 white, unfenestrated, radiopaque inner cannula
- obturator, perforated
- funnel connector
- neck strap
- lubricant gel

PU = 1 set  
sterile packaged



SIZE	ID <sub>ic</sub>	ID <sub>oc</sub>	OD	LENGTH ALONG CENTRE LINE (OC)	LENGTH ALONG OUTER BEND (OC)	ARTICLE NUMBER PDT SET
7	5,4 mm	7,0 mm	10,5 mm	70,0 mm	79,0 mm	112454
8	6,4 mm	8,0 mm	11,6 mm	75,5 mm	87,0 mm	112455
9	7,4 mm	9,0 mm	12,6 mm	81,0 mm	93,0 mm	112456

ID = INNER DIAMETER  
OD = OUTER DIAMETER  
PU = PACKAGING UNIT

IC = INNER CANNULA  
OC = OUTER CANNULA

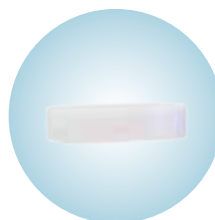

**OBTURATOR & NECK STRAP INCLUDED**

PERCUTRACH® PDT SET TYPE 1

Package contents per set:

**PERCUTRACH®** Dilation set I

Including:

- pre-dilator (14 CH)
- puncture cannula (14G)
- dilator (hydrophilic coating)
- guiding catheter with safety lock
- guide wire with dispenser
- gauze compresses
- syringe
- scalpel

and

**OPTIMA PERCUTRACH®** Suction Voice

with atraumatic inserter

Including:

- fenestrated outer cannula with cuff, subglottic suction function and 15 mm universal connector
- atraumatic inserter
- 1 red, fenestrated inner cannula
- 1 white, unfenestrated, radiopaque inner cannula
- obturator, perforated
- funnel connector
- decannulation cap
- speaking valve
- neck strap
- lubricant gel

PU = 1 set  
sterile packaged



SIZE	ID <sub>ic</sub>	ID <sub>oc</sub>	OD	LENGTH ALONG CENTRE LINE (OC)	LENGTH ALONG OUTER BEND (OC)	ARTICLE NUMBER PDT SET
7	5,4 mm	7,0 mm	10,5 mm	70,0 mm	79,0 mm	112444
8	6,4 mm	8,0 mm	11,6 mm	75,5 mm	87,0 mm	112445
9	7,4 mm	9,0 mm	12,6 mm	81,0 mm	93,0 mm	112446

ID = INNER DIAMETER  
OD = OUTER DIAMETER  
PU = PACKAGING UNIT

IC = INNER CANNULA  
OC = OUTER CANNULA

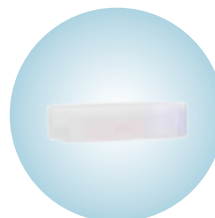

OBTURATOR & NECK STRAP INCLUDED



**PDT SET TYPE 2**



# DILATATION TRACHEOSTOMY

DEVELOPED BY GRIGGS

The percutaneous dilatation tracheostomy technique according to Griggs is a minimal-invasive treatment as well. This method implies the tracheal dilation by a tracheal dilating forceps. The closed forceps, featuring a longitudinal duct, is pushed into the trachea via a guide wire. Then the forceps is spread and thus dilates the trachea until the insertion of the required tracheostomy tube is possible.

This technique is a quick and efficient, tissue-conserving dilation procedure and, similar to the Ciaglia method, is characterized by a small skin incision and causing few complications.

The procedure is performed under bronchoscopic control.



Position patient with hyperextension of neck, cover area around the neck with sterile dressing, disinfect skin

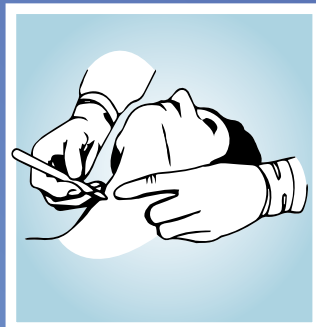

Palpation of neck, sonography (recommended), diaphanoscopy of neck area (obligatory), horizontal incision (1,5-2,0 cm) and blunt preparation up to trachea



Puncture of trachea



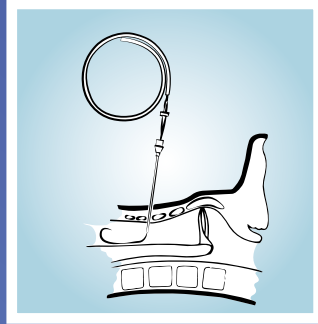

Insertion of guide wire (Seldinger wire)

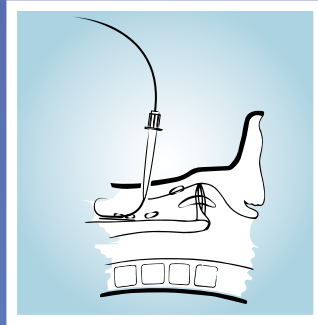

Opening of injection canal by pre-dilator

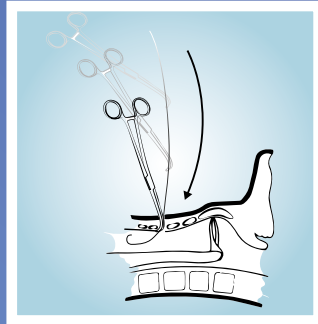

Insert closed tracheal dilating forceps via guide wire and dilate pre-tracheal tissue first.

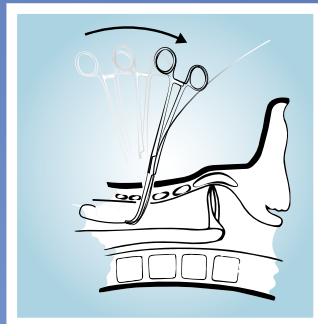

Insert forceps further into trachea and dilate tracheal tissue by spreading.

Remove spread forceps.

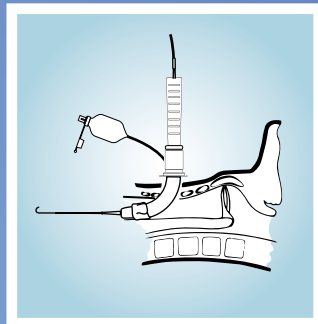

Moisten tip of atraumatic inserter with lubricant and insert in tracheal orifice via guide wire together with tested tracheostomy tube.

Remove atraumatic inserter and guide wire simultaneously.

**PERCUTRACH® PDT SET TYPE 2**



**Package contents per set:**

**PERCUTRACH®** Dilatation set II

Including:

- tracheal dilating forceps
- pre-dilator (14 CH)
- puncture cannula (14G)
- gauze compresses
- syringe
- scalpel
- guide wire with dispenser

*and*

**OPTIMA PERCUTRACH®** Basic Cuff  
with atraumatic inserter

Including:

- outer cannula with cuff and 15 mm universal connector
- atraumatic inserter
- 1 transparent, unfenestrated inner cannula
- 1 white, unfenestrated, radiopaque inner cannula
- obturator, perforated
- neck strap
- lubricant gel

PU = 1 set  
sterile packaged

SIZE	ID <sub>IC</sub>	ID <sub>OC</sub>	OD	LENGTH ALONG CENTRE LINE (OC)	LENGTH ALONG OUTER BEND (OC)	ARTICLE NUMBER PDT SET
7	5,4 mm	7,0 mm	10,5 mm	70,0 mm	79,0 mm	112324
8	6,4 mm	8,0 mm	11,6 mm	75,5 mm	87,0 mm	112325
9	7,4 mm	9,0 mm	12,6 mm	81,0 mm	93,0 mm	112326

ID = INNER DIAMETER  
OD = OUTER DIAMETER  
PU = PACKAGING UNIT

IC = INNER CANNULA  
OC = OUTER CANNULA

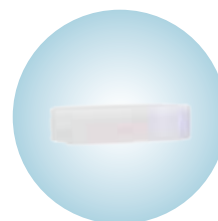

**OBTURATOR & NECK STRAP INCLUDED**

**PERCUTRACH® PDT SET TYPE 2**

**Package contents per set:**

**PERCUTRACH®** Dilation set II

Including:

- tracheal dilating forceps
- pre-dilator (14 CH)
- puncture cannula (14G)
- gauze compresses
- syringe
- scalpel
- guide wire with dispenser

*and*

**OPTIMA PERCUTRACH®** Voice Cuff  
with atraumatic inserter

Including:

- fenestrated outer cannula with cuff and 15 mm universal connector
- atraumatic inserter
- 1 red, fenestrated inner cannula
- 1 white, unfenestrated, radiopaque inner cannula
- obturator, perforated
- decannulation cap
- speaking valve
- neck strap
- lubricant gel

PU = 1 set  
sterile packaged



SIZE	ID <sub>IC</sub>	ID <sub>OC</sub>	OD	LENGTH ALONG CENTRE LINE (OC)	LENGTH ALONG OUTER BEND (OC)	ARTICLE NUMBER PDT SET
7	5,4 mm	7,0 mm	10,5 mm	70,0 mm	79,0 mm	112334
8	6,4 mm	8,0 mm	11,6 mm	75,5 mm	87,0 mm	112335
9	7,4 mm	9,0 mm	12,6 mm	81,0 mm	93,0 mm	112336

ID = INNER DIAMETER  
OD = OUTER DIAMETER  
PU = PACKAGING UNIT

IC = INNER CANNULA  
OC = OUTER CANNULA

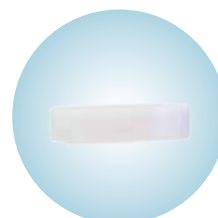

**OBTURATOR  
& NECK STRAP  
INCLUDED**

**PERCUTRACH® PDT SET TYPE 2**



**Package contents per set:**

**PERCUTRACH®** Dilation set II

Including:

- tracheal dilating forceps
- pre-dilator (14 CH)
- puncture cannula (14G)
- gauze compresses
- syringe
- scalpel
- guide wire with dispenser

*and*

**OPTIMA PERCUTRACH®** Suction

with atraumatic inserter

Including:

- outer cannula with cuff, subglottic suction function and 15 mm universal connector
- atraumatic inserter
- 1 transparent, unfenestrated inner cannula
- 1 white, unfenestrated, radiopaque inner cannula
- obturator, perforated
- funnel connector
- neck strap
- lubricant gel

PU = 1 set  
sterile packaged



SIZE	ID <sub>IC</sub>	ID <sub>OC</sub>	OD	LENGTH ALONG CENTRE LINE (OC)	LENGTH ALONG OUTER BEND (OC)	ARTICLE NUMBER PDT SET
7	5,4 mm	7,0 mm	10,5 mm	70,0 mm	79,0 mm	112354
8	6,4 mm	8,0 mm	11,6 mm	75,5 mm	87,0 mm	112355
9	7,4 mm	9,0 mm	12,6 mm	81,0 mm	93,0 mm	112356

ID = INNER DIAMETER  
OD = OUTER DIAMETER  
PU = PACKAGING UNIT

IC = INNER CANNULA  
OC = OUTER CANNULA

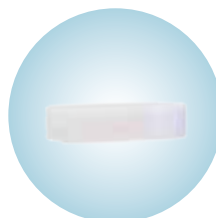

**OBTURATOR & NECK STRAP INCLUDED**

**PERCUTRACH® PDT SET TYPE 2**



**Package contents per set:**

**PERCUTRACH®** Dilation set II

Including:

- tracheal dilating forceps
- pre-dilator (14 CH)
- puncture cannula (14G)
- gauze compresses
- syringe
- scalpel
- guide wire with dispenser

*and*

**OPTIMA PERCUTRACH®** SuctionVoice

with atraumatic inserter

Including:

- fenestrated outer cannula with cuff, subglottic suction function and 15 mm universal connector
- atraumatic inserter
- 1 red, fenestrated inner cannula
- 1 white, unfenestrated, radiopaque inner cannula
- obturator, perforated
- funnel connector
- decannulation cap
- speaking valve
- neck strap
- lubricant gel

PU = 1 set  
sterile packaged



SIZE	ID <sub>ic</sub>	ID <sub>oc</sub>	OD	LENGTH ALONG CENTRE LINE (OC)	LENGTH ALONG OUTER BEND (OC)	ARTICLE NUMBER PDT SET
7	5,4 mm	7,0 mm	10,5 mm	70,0 mm	79,0 mm	112344
8	6,4 mm	8,0 mm	11,6 mm	75,5 mm	87,0 mm	112345
9	7,4 mm	9,0 mm	12,6 mm	81,0 mm	93,0 mm	112346

ID = INNER DIAMETER  
OD = OUTER DIAMETER  
PU = PACKAGING UNIT

IC = INNER CANNULA  
OC = OUTER CANNULA

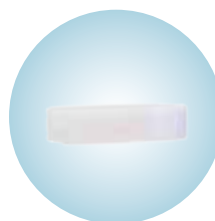

**OBTURATOR & NECK STRAP INCLUDED**

## SET COMPONENTS

The different components of the **PDT Sets** are also available separately and can be combined individually.



Dilatation Set I  
(according to the method  
developed by Ciaglia)



Dilatation Set II  
(according to the method  
developed by Griggs)



Optima PercuTrach®  
with atraumatic inserter



**DILATION SETS**

**DILATION SETS**

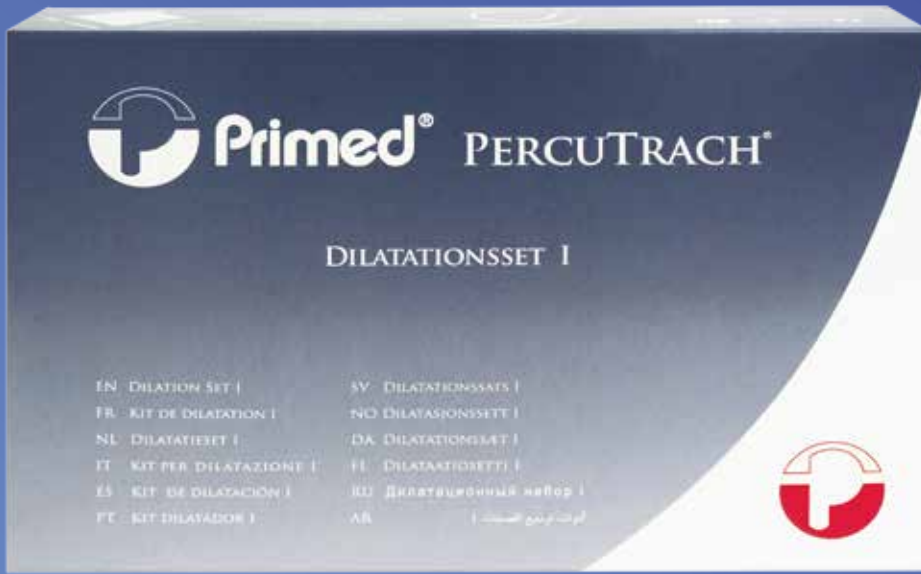

## DILATION SET I

## DILATION SET I

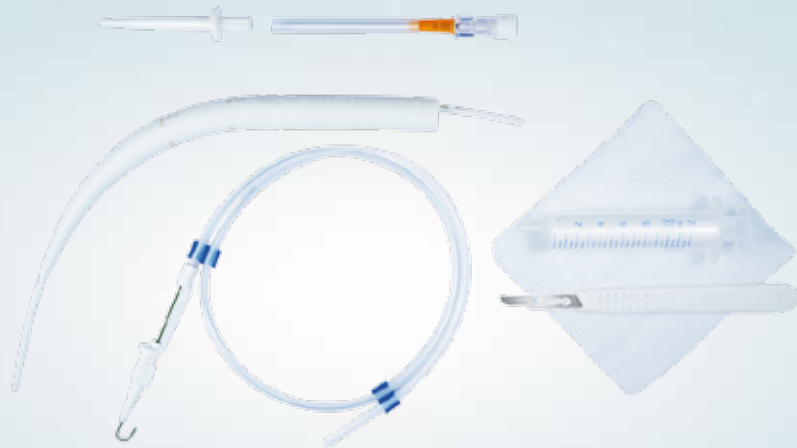

PERCUTRACH®

Dilation set I

Including:

- pre-dilator (14 CH)
- puncture cannula (14G)
- dilator (hydrophilic coating)
- guiding catheter with safety lock
- guide wire with dispenser
- gauze compresses
- syringe
- scalpel

PU = 1 set  
sterile packaged

ARTICLE NUMBER

102086

PU = PACKAGING UNIT

## DILATION SET II

## DILATION SET II



## PERCUTRACH® Dilation Set II

Including:

- tracheal dilating forceps
- pre-dilator (14 CH)
- puncture cannula (14G)
- gauze compresses
- syringe
- scalpel
- guide wire with dispenser

PU = 1 set  
sterile packaged

ARTICLE NUMBER

102087

PU = PACKAGING UNIT

# OPTIMA PERCUTRACH®



WITH ATRAUMATIC  
INSERTER

OPTIMA PERCUTRACH®

OPTIMA PERCUTRACH® Basic Cuff  
with atraumatic inserter

Including:

- outer cannula with cuff and 15 mm universal connector
- atraumatic inserter
- 1 transparent, unfenestrated inner cannula
- 1 white, unfenestrated, radiopaque inner cannula
- obturator, perforated
- neck strap
- lubricant gel

PU = 1 set  
sterile packaged



SIZE	ID <sub>IC</sub>	ID <sub>OC</sub>	OD	LENGTH ALONG CENTRE LINE (OC)	LENGTH ALONG OUTER BEND (OC)	ARTICLE NUMBER
7	5,4 mm	7,0 mm	10,5 mm	70,0 mm	79,0 mm	102424
8	6,4 mm	8,0 mm	11,6 mm	75,5 mm	87,0 mm	102425
9	7,4 mm	9,0 mm	12,6 mm	81,0 mm	93,0 mm	102426

OPTIMA PERCUTRACH® Voice Cuff  
with atraumatic inserter

Including:

- fenestrated outer cannula with cuff and 15 mm universal connector
- atraumatic inserter
- 1 red, fenestrated inner cannula
- 1 white, unfenestrated, radiopaque inner cannula
- obturator, perforated
- decannulation cap
- speaking valve
- neck strap
- lubricant gel

PU = 1 set  
sterile packaged



SIZE	ID <sub>IC</sub>	ID <sub>OC</sub>	OD	LENGTH ALONG CENTRE LINE (OC)	LENGTH ALONG OUTER BEND (OC)	ARTICLE NUMBER
7	5,4 mm	7,0 mm	10,5 mm	70,0 mm	79,0 mm	102434
8	6,4 mm	8,0 mm	11,6 mm	75,5 mm	87,0 mm	102435
9	7,4 mm	9,0 mm	12,6 mm	81,0 mm	93,0 mm	102436

ID = INNER DIAMETER  
OD = OUTER DIAMETER  
PU = PACKAGING UNIT

IC = INNER CANNULA  
OC = OUTER CANNULA

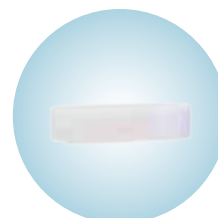

OBTURATOR  
& NECK STRAP  
INCLUDED

WITH ATRAUMATIC  
INSERTER

OPTIMA PERCUTRACH®



OPTIMA PERCUTRACH® Suction  
with atraumatic inserter

Including:

- outer cannula with cuff, subglottic suction function and 15 mm universal connector
- atraumatic inserter
- 1 transparent, unfenestrated inner cannula
- 1 white, unfenestrated, radiopaque inner cannula
- obturator, perforated
- funnel connector
- neck strap
- lubricant gel

PU = 1 set  
sterile packaged

SIZE	ID <sub>IC</sub>	ID <sub>OC</sub>	OD	LENGTH ALONG CENTRE LINE (OC)	LENGTH ALONG OUTER BEND (OC)	ARTICLE NUMBER
7	5,4 mm	7,0 mm	10,5 mm	70,0 mm	79,0 mm	102454
8	6,4 mm	8,0 mm	11,6 mm	75,5 mm	87,0 mm	102455
9	7,4 mm	9,0 mm	12,6 mm	81,0 mm	93,0 mm	102456



OPTIMA PERCUTRACH® SuctionVoice  
with atraumatic inserter

Including:

- fenestrated outer cannula with cuff, subglottic suction function and 15 mm universal connector
- atraumatic inserter
- 1 red, fenestrated inner cannula
- 1 white, unfenestrated, radiopaque inner cannula
- obturator, perforated
- funnel connector
- decannulation cap
- speaking valve
- neck strap
- lubricant gel

PU = 1 set  
sterile packaged

SIZE	ID <sub>IC</sub>	ID <sub>OC</sub>	OD	LENGTH ALONG CENTRE LINE (OC)	LENGTH ALONG OUTER BEND (OC)	ARTICLE NUMBER
7	5,4 mm	7,0 mm	10,5 mm	70,0 mm	79,0 mm	102444
8	6,4 mm	8,0 mm	11,6 mm	75,5 mm	87,0 mm	102445
9	7,4 mm	9,0 mm	12,6 mm	81,0 mm	93,0 mm	102446

ID = INNER DIAMETER  
OD = OUTER DIAMETER  
PU = PACKAGING UNIT

IC = INNER CANNULA  
OC = OUTER CANNULA

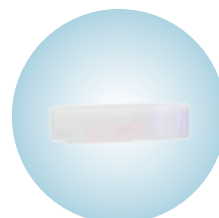

OBTURATOR  
& NECK STRAP  
INCLUDED



ACCESSORIES



OPTIMA PERCUTRACH®

single inner cannulas

Inner cannulas are available in different variants:

- transparent, unfenestrated
- red, fenestrated
- white, unfenestrated, radiopaque

PU = 5 pieces  
sterile packaged

SIZE	ID	TRANSPARENT, UNFENESTRATED (A)	RED, FENESTRATED (B)	WHITE, UNFENESTRATED, RADIOPAQUE (C)	PU
7	5,4 mm	102019	102029	102039	5/ Box
8	6,4 mm	102020	102030	102040	5/ Box
9	7,4 mm	102021	102031	102041	5/ Box



Guide wire with dispenser (Seldinger wire)

- made of kink-resistant NiTiNOL
- individually sterile packaged

PU = 5 pieces  
sterile packaged

ARTICLE NUMBER

102090

ID = INNER DIAMETER  
PU = PACKAGING UNIT



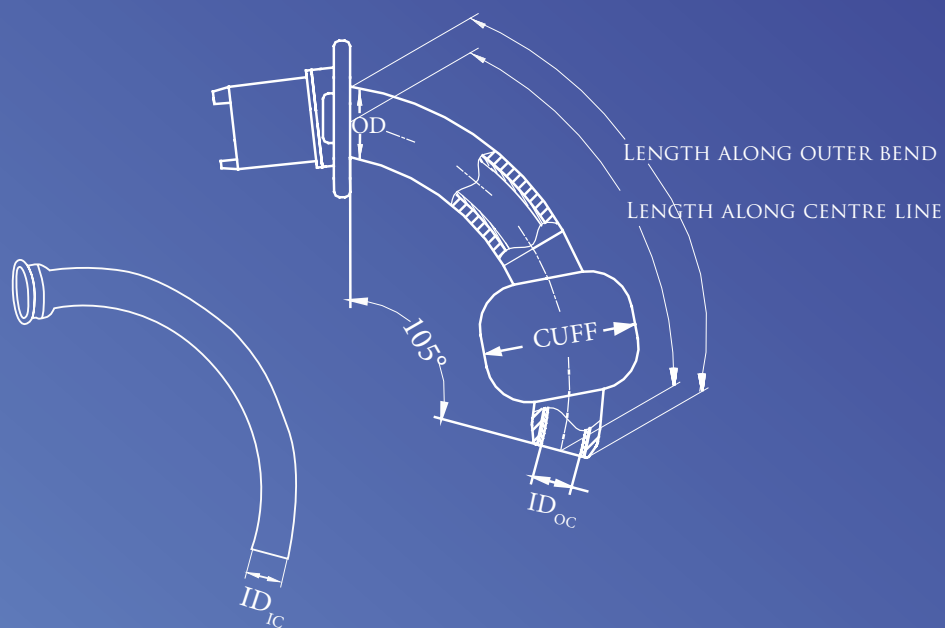

### MEASUREMENT CHART FOR OPTIMA PERCU<sup>®</sup>TRACH<sup>®</sup>:

FOR THE TYPES  
**BASIC CUFF, VOICE CUFF, SUCTION AND SUCTION VOICE**

SIZE	ID <sub>IC</sub>	ID <sub>OC</sub>	OD	LENGTH ALONG CENTRE LINE (OC)	LENGTH ALONG OUTER BEND (OC)
7	5,4 mm	7,0 mm	10,5 mm	70,0 mm	79,0 mm
8	6,4 mm	8,0 mm	11,6 mm	75,5 mm	87,0 mm
9	7,4 mm	9,0 mm	12,6 mm	81,0 mm	93,0 mm

ID<sub>IC</sub> = INNER DIAMETER OF INNER CANNULA AT BOTTOM OF TUBE

ID<sub>OC</sub> = INNER DIAMETER OF OUTER CANNULA AT BOTTOM OF TUBE

OD = OUTER DIAMETER OF OUTER CANNULA BEHIND THE FLANGE

IC = INNER CANNULA

OC = OUTER CANNULA

MANUFACTURER

---

**Primed**<sup>®</sup> HALBERSTADT  
MEDIZINTECHNIK GMBH  
STRASSE DES 20. JULI 1  
D-38820 HALBERSTADT  
PHONE.: 0049-(0)3941-668-6  
FAX: 0049-(0)3941-24565  
PRIMED@PRIMED-HALBERSTADT.DE

DISTRIBUTOR

---

ALL RIGHTS TO TECHNICAL MODIFICATIONS RESERVED!

REVISION STATUS: SEPTEMBER 2015